

Specification: TF-KT31H

- 1/4 turn ceramic disc flow control
- Triflow Stainless Steel push fit filter housing
- Flexible connections
- Swivel spout

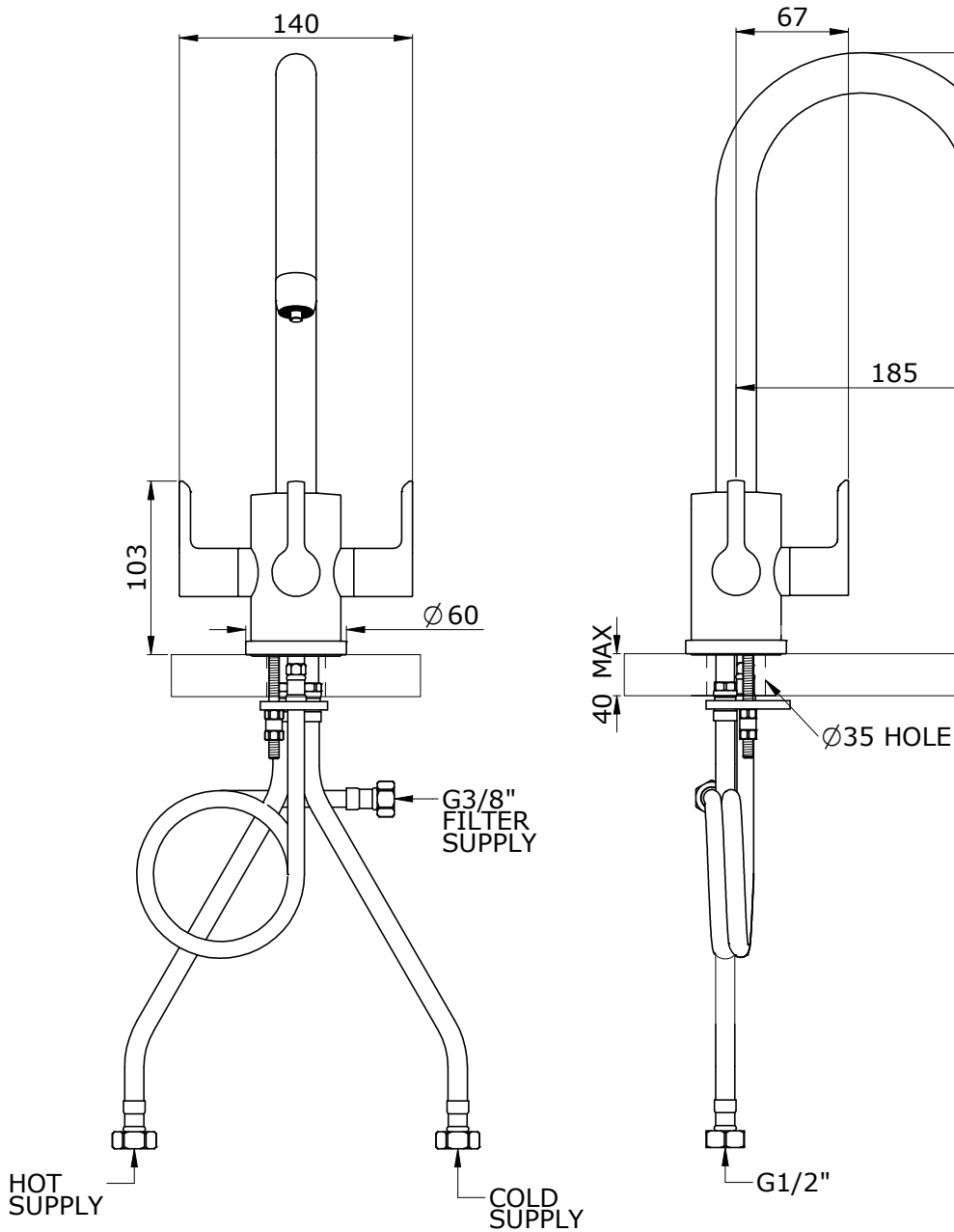

Temp Range:
Min 1°C / 34°F
Max 85°C / 185°F

Recommended Working Pressure:
Min 1bar / 15psi
Max 5bar / 75psi

Available Finishes:

- Chrome